

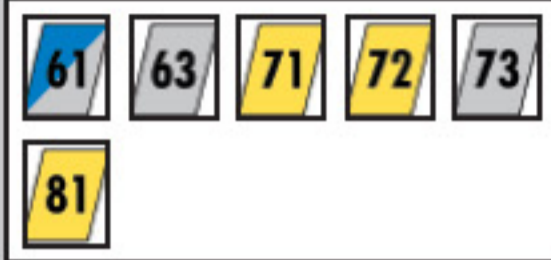

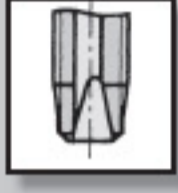







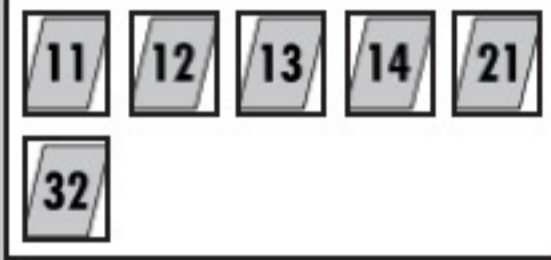





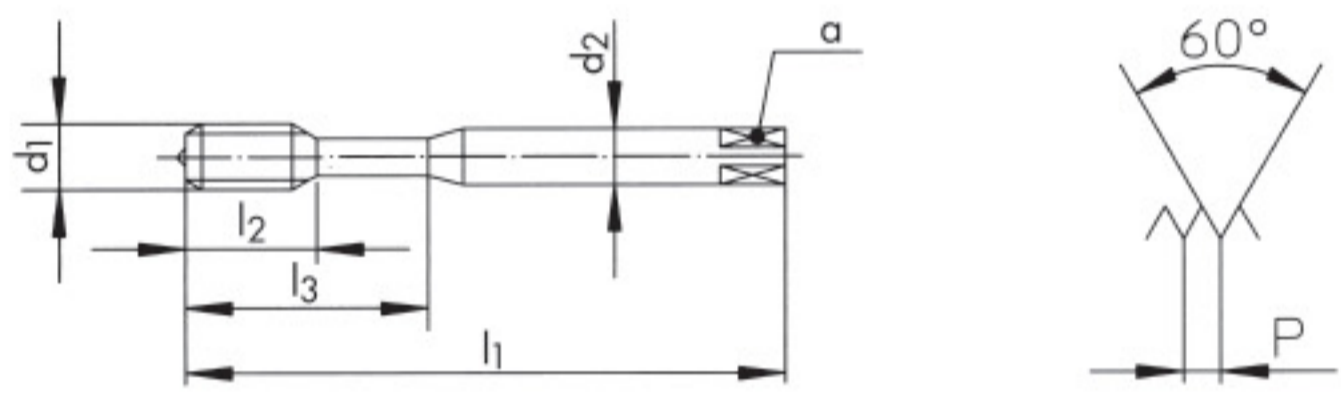
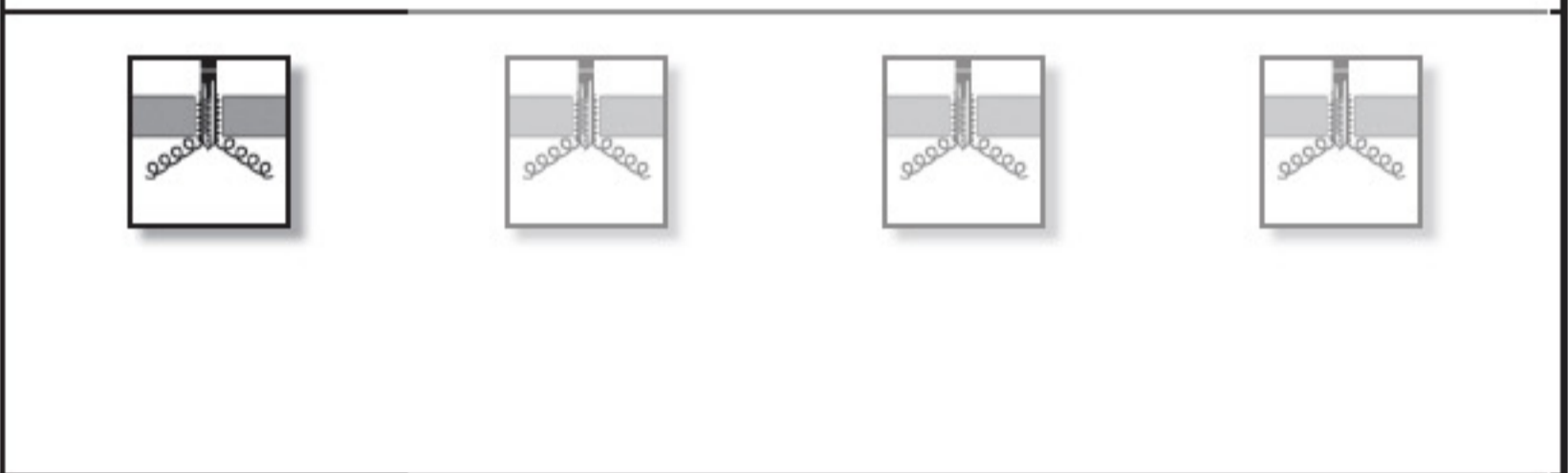

	N320-4	N320V-4	N320TN-4	N320TC-4
<b>N320-4</b>				
				
<b>N320V-4</b>				
				
<b>N320TN-4</b>				
				
<b>N320TC-4</b>				
				



Ø d <sub>1</sub> M	P mm	l <sub>1</sub> mm	l <sub>2</sub> mm	l <sub>3</sub> mm	d <sub>2</sub> mm	a mm			ID	ID	ID	ID
*1	0.25	40	5.5		2.5	2.1	2	0.75	111467			
*1.1	0.25	40	5.5		2.5	2.1	2	0.85	111468			
*1.2	0.25	40	5.5		2.5	2.1	2	0.95	111469			
*1.4	0.30	40	7.0		2.5	2.1	2	1.10	111470			
*1.5	0.30	40	7.0		2.5	2.1	2	1.20	111471			
*1.6	0.35	40	8.0		2.5	2.1	2	1.25	101454			
*1.7	0.35	40	8.0		2.5	2.1	2	1.35	101455			
*1.8	0.35	40	8.0		2.5	2.1	2	1.45	101456			
*2	0.40	45	8.0		2.8	2.1	2	1.60	101458	101536	101528	152900
*2.2	0.45	45	9.0		2.8	2.1	2	1.75	101459			
*2.3	0.40	45	9.0		2.8	2.1	2	1.90	101460			
2.5	0.45	50	10.0		2.8	2.1	3	2.05	101483	101545	101530	101522
2.6	0.45	50	10.0		2.8	2.1	3	2.15	101484			
3	0.50	56	12.0	18	3.5	2.7	3	2.50	101485	101546	101531	101523
3.5	0.60	56	13.0	20	4.0	3.0	3	2.90	101491	101547		
4	0.70	63	14.0	21	4.5	3.4	3	3.30	101495	101548	101532	101524
5	0.80	70	15.0	25	6.0	4.9	3	4.20	101499	101549	101533	101525
6	1.00	80	17.0	30	6.0	4.9	3	5.00	101503	101550	101534	101526
8	1.25	90	20.0	35	8.0	6.2	3	6.80	101506	101551	101535	101527
10	1.50	100	22.0	39	10.0	8.0	3	8.50	101481	101544	101529	101521

\* N320-3 / N320V-3  
 N320TN-3 / N320TC-3



≤ M1.5    **ISO 1 4H**