

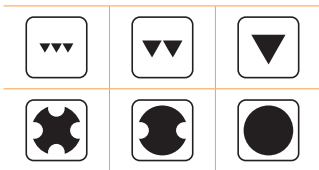

PCLN(RL) EXT

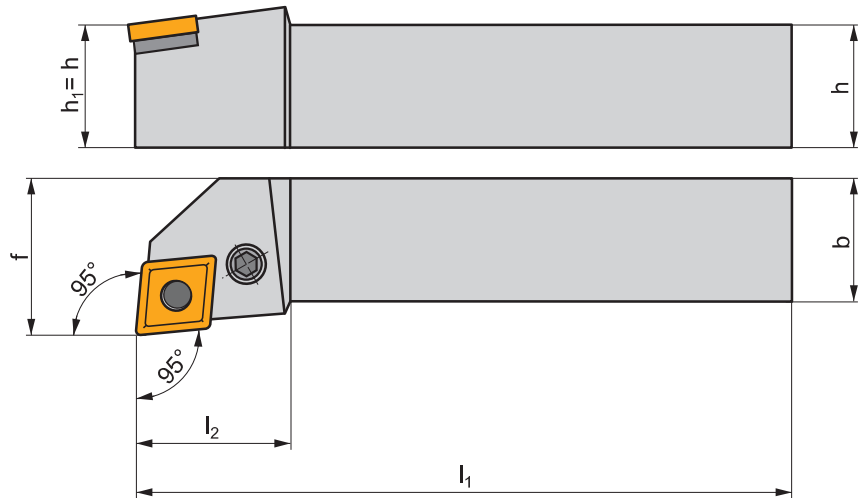

P M K N S H

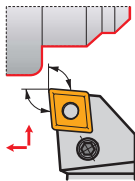









 | T48-T60, T140

P



ISO	h=h ₁	b	f	l ₁	l ₂	λ _s °	γ°	kg		
PCLNR/L 2020 K 12	20	20	25	125	36,0	-6	-6	0,42	GI043	PC22
PCLNR/L 2525 M 12	25	25	32	150	36,0	-6	-6	0,68	GI043	PC20
PCLNR/L 3225 P 12	32	25	32	170	36,0	-6	-6	0,85	GI043	PC20
PCLNR/L 3225 P 16	32	25	32	170	40,0	-6	-6	1,10	GI050	PC40
PCLNR/L 3232 P 19	32	32	40	170	45,0	-6	-6	1,40	GI042	PC50
PCLNR/L 4040 R 19	40	40	50	200	45,0	-6	-6	2,60	GI042	PC50
PCLNR/L 4040 S 19	40	40	50	250	45,0	-6	-6	3,15	GI042	PC50
PCLNR/L 4040 S 25	40	40	50	250	45,0	-6	-6	3,20	GI062	PC60
PCLNR/L 5050 T 25	50	50	60	300	50,0	-6	-6	5,80	GI062	PC60

	
GI042	CN.. 1906..
GI043	CN.. 1204..
GI050	CN.. 1606..
GI062	CN.. 2509..

									
PC20	CNU 120312	PU 02	US 35	6,0	M8x1	22,5	NT 05	MT 05	HXK 4
PC22	CNU 120312	PU 02	US 42	6,0	M8x1	21	NT 05	MT 05	HXK 4
PC40	CNU 150312	PU 04	US 36	6,0	M8x1	26	NT 07	MT 07	HXK 4
PC50	CNU 190416	PU 05	US 38	8,0	M10x1	29	NT 06	MT 06	HXK 5
PC60	CNU 250620	PU 06	US 39	8,0	M10x1	33	NT 08	MT 08	HXK 5